

Datenblatt:

981+0089+000

SW-LM 0-0-1 (8Kg)



Schwenkbereich umlaufend 35°

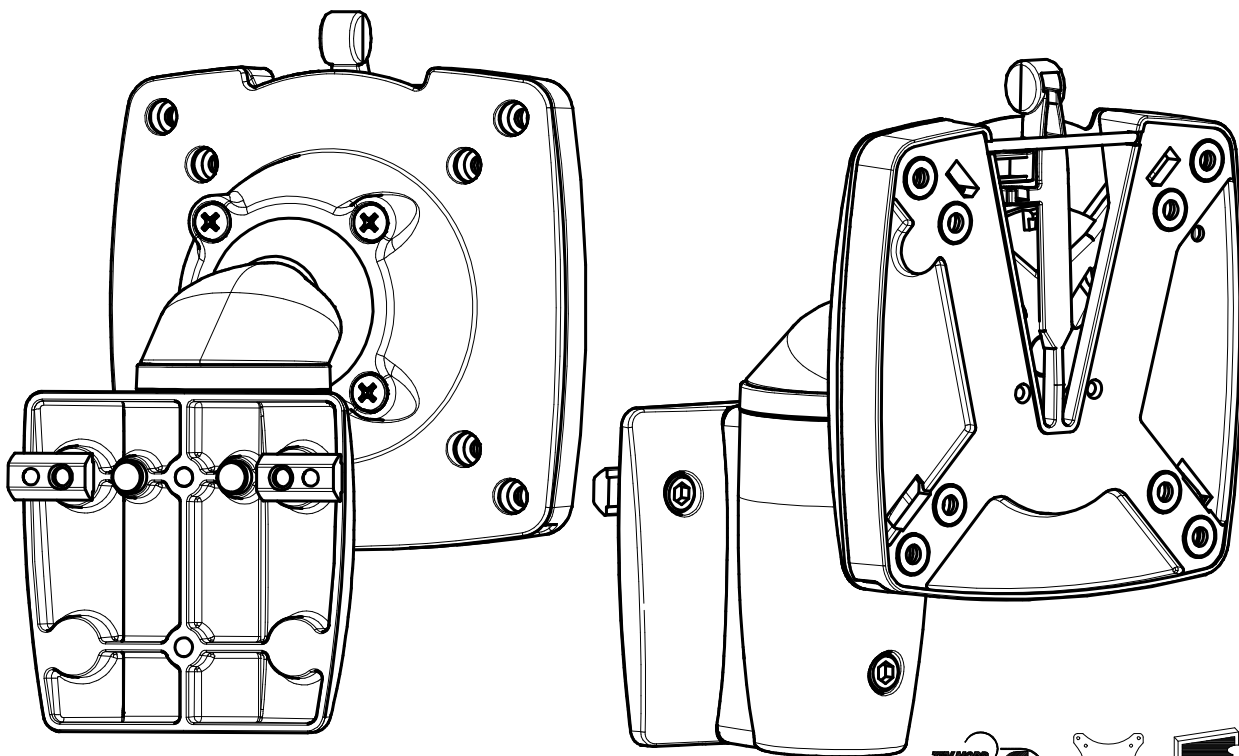
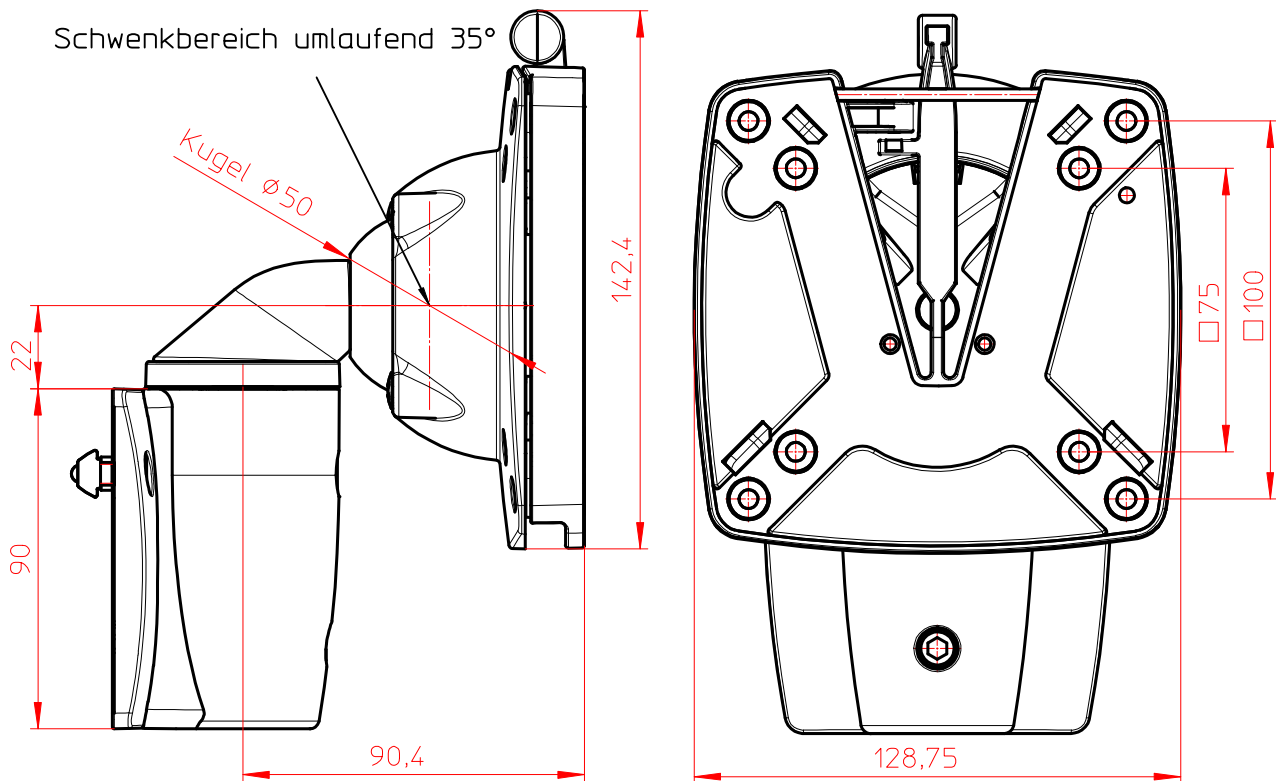

Technische und Design Änderungen vorbehalten!  
Technical and design modifications reserved! 15.10.10